



¡Haz base!

pasteloso

Product Catalog
2023



Table of Contents

- 2 **Round** Single Wall Cake Board "**C**" flute
- 4 **Round** Cake Board "**BC**" flute
- 6 **Rectangular** Single Wall Cake Pad "**C**" flute
- 8 **Rectangular** Cake Pad "**BC**" flute
- 10 **Round** Embossed Cake Drum
- 12 **Rectangular** Embossed Cake Pads
- 14 **Round** Ribbon Cake Board 2 "**BC**" heavy duty
- 16 **Round** Slim cake board "**very sturdy**"
- 18 **Round Golden** Cake Pad
- 20 **Mono portion** boards "**Frida**"
- 22 **Donut Box** "**CCNB**"
- 24 **Muffin box** "**CCNB**"
- 26 **Hexagonal** Cake Box "**Chipboard**"
- 28 **Transporter** Cake Box "**C**" flute
- 30 **Cake Box** without window "**E**" flute
 - Cake Box** with window "**E**" flute
- 32 **Tall Cake Box** with window "**E**" flute
- 34 **Surprise** Cake Box "**E**" flute
- 36 **Cardboard Bakeable** Box
- 38 **Paper Stick**

Round Single Wall Cake Board "C" flute

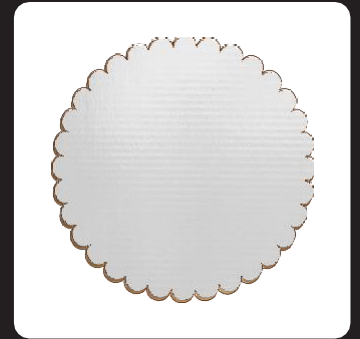
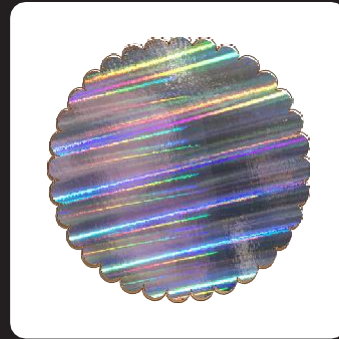
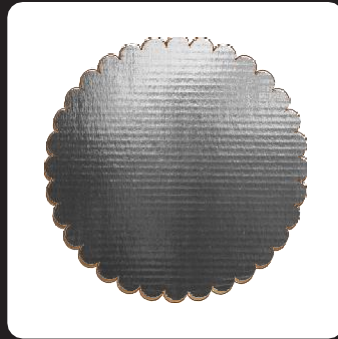
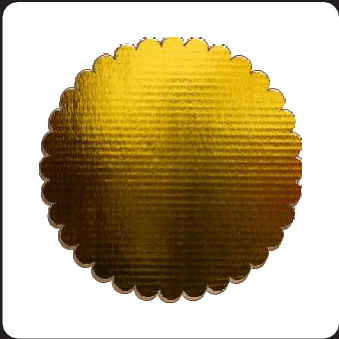
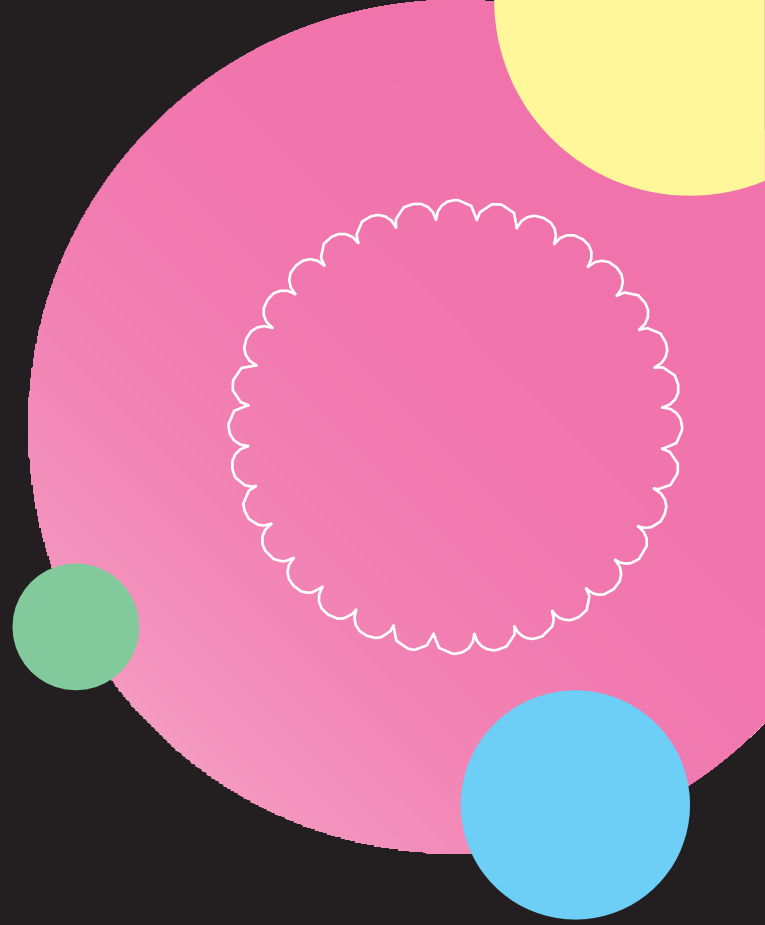

Introducing our round cake boards made from high-quality "C" flute single-wall cardboard, providing a sturdy and durable base for your cakes. Available in 4 elegant colors - silver, gold, holographic, and white - these cake boards are perfect for displaying your creations. The board has a scalloped edge and a moisture-resistant metallic coating, ensuring that your cake stays in perfect condition.

Round

Single Wall Cake Board "C" flute

Model	Description	Size	Pack
BGSW08"	GOLD single wall cake board	08"	100
BGSW10"	GOLD single wall cake board	10"	100
BGSW12"	GOLD single wall cake board	12"	100

Model	Description	Size	Pack
BSSW08"	SILVER single wall cake board	08"	100
BSSW10"	SILVER single wall cake board	10"	100
BSSW12"	SILVER single wall cake board	12"	100

Model	Description	Size	Pack
BFSW08"	FANTASY single wall cake board	08"	100
BFSW10"	FANTASY single wall cake board	10"	100
BFSW12"	FANTASY single wall cake board	12"	100

Model	Description	Size	Pack
BWSW08"	WHITE single wall cake board	08"	100
BWSW10"	WHITE single wall cake board	10"	100
BWSW12"	WHITE single wall cake board	12"	100

Round Cake Board "BC" flute

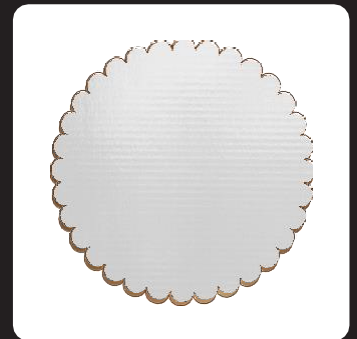
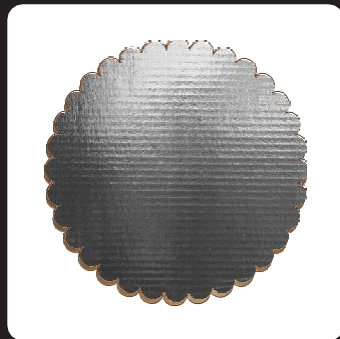
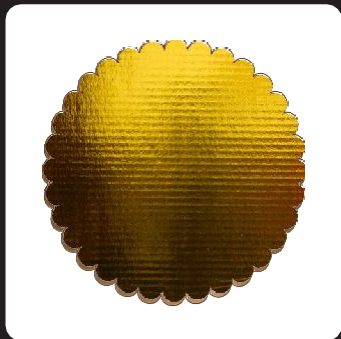
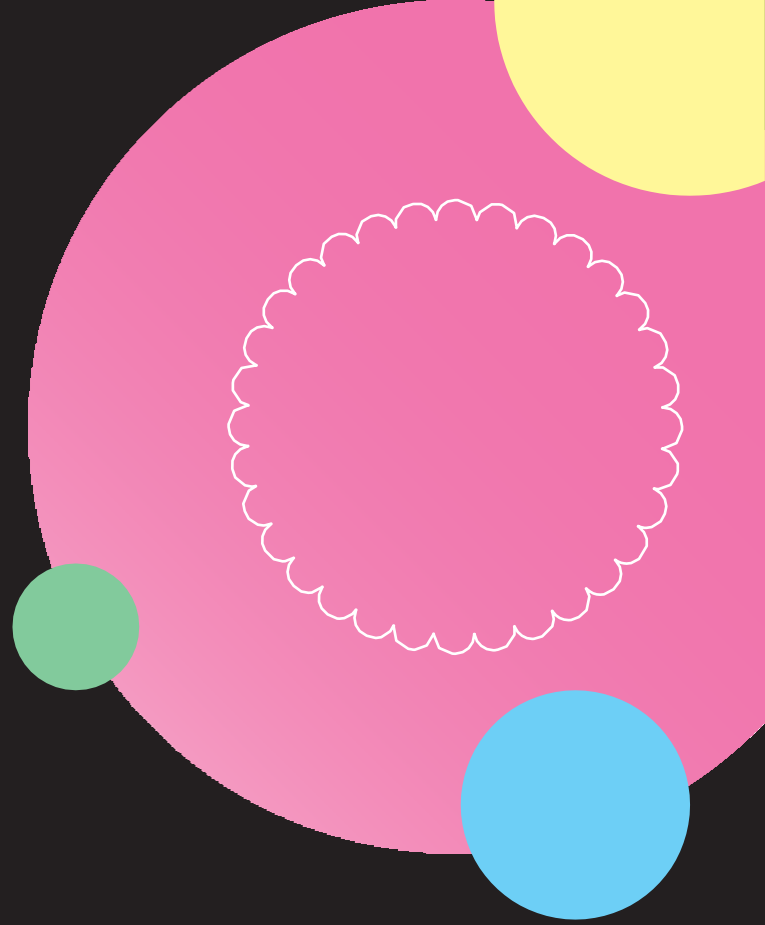
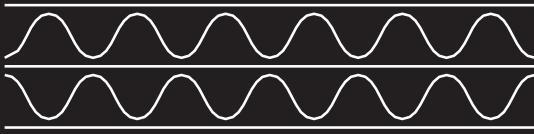

Our round cake boards are the perfect solution for displaying your cakes. Made from high-quality "BC" flute double-wall cardboard, these boards are extremely sturdy and durable. Available in 4 elegant colors - silver, gold, holographic, and white - the board has a scalloped edge and a moisture-resistant metallic coating, ensuring that your cake stays in perfect condition.

Round

Cake Board "BC" flute

Model	Description	Size	Pack
BGDW06"	GOLD double wall cake board	06"	50
BGDW07"	GOLD double wall cake board	07"	50
BGDW08"	GOLD double wall cake board	08"	50
BGDW09"	GOLD double wall cake board	09"	50
BGDW10"	GOLD double wall cake board	10"	50
BGDW12"	GOLD double wall cake board	12"	50
BGDW14"	GOLD double wall cake board	14"	50
BGDW16"	GOLD double wall cake board	16"	50
BSDW06"	SILVER double wall cake board	06"	50
BSDW07"	SILVER double wall cake board	07"	50
BSDW08"	SILVER double wall cake board	08"	50
BSDW09"	SILVER double wall cake board	09"	50
BSDW10"	SILVER double wall cake board	10"	50
BSDW12"	SILVER double wall cake board	12"	50
BSDW14"	SILVER double wall cake board	14"	50
BSDW16"	SILVER double wall cake board	16"	50
BFDW06"	FANTASY double wall cake board	06"	50
BFDW07"	FANTASY double wall cake board	07"	50
BFDW08"	FANTASY double wall cake board	08"	50
BFDW09"	FANTASY double wall cake board	09"	50
BFDW10"	FANTASY double wall cake board	10"	50
BFDW12"	FANTASY double wall cake board	12"	50
BFDW14"	FANTASY double wall cake board	14"	50
BFDW16"	FANTASY double wall cake board	16"	50
BWDW06"	WHITE double wall cake board	06"	50
BWDW07"	WHITE double wall cake board	07"	50
BWDW08"	WHITE double wall cake board	08"	50
BWDW09"	WHITE double wall cake board	09"	50
BWDW10"	WHITE double wall cake board	10"	50
BWDW12"	WHITE double wall cake board	12"	50
BWDW14"	WHITE double wall cake board	14"	50
BWDW16"	WHITE double wall cake board	16"	50

Rectangular Single Wall Cake Pad "C" flute

0.142-inch thickness

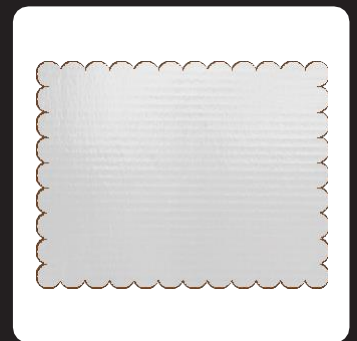
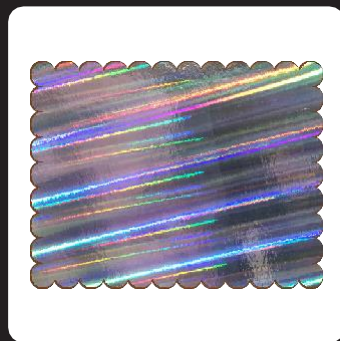
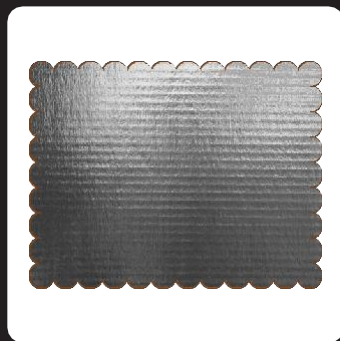
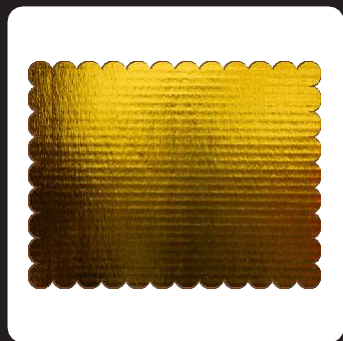
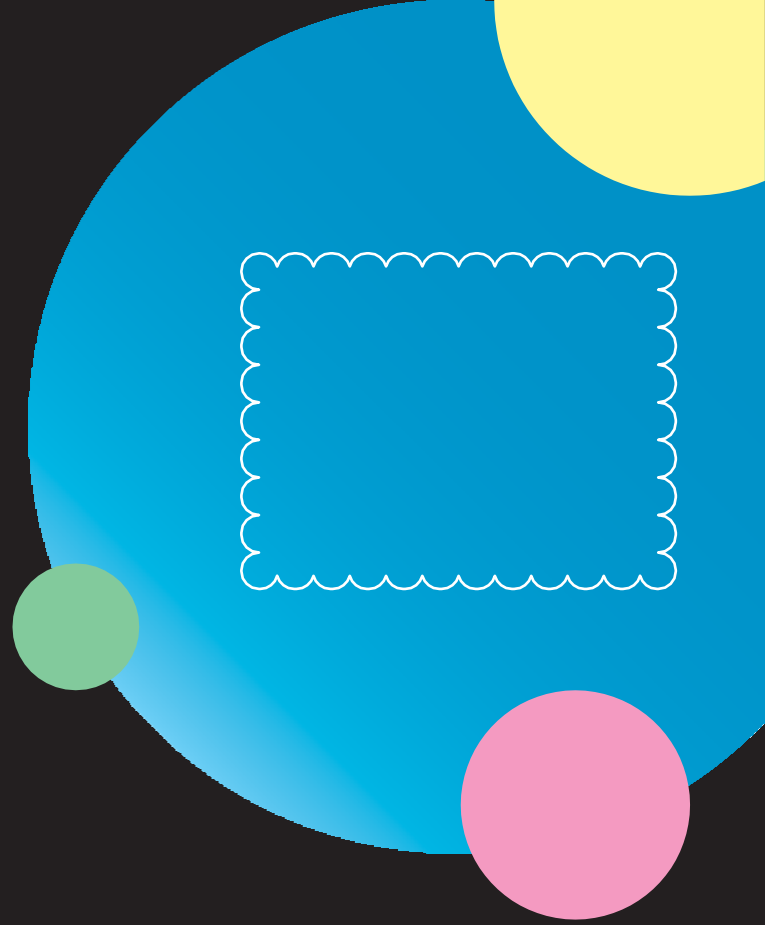
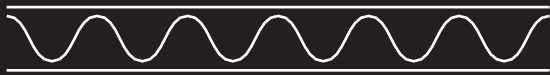

Our rectangular cake pads are perfect for displaying your rectangular cakes. Made from high-quality "C" flute single-wall cardboard, these cake pads provide a sturdy and durable base for your cakes. Available in 4 elegant colors - silver, gold, holographic, and white - the pad has a scalloped edge and a moisture-resistant metallic coating, ensuring that your cake stays in perfect condition.

Rectangle

Single Wall Cake Pad "C" flute

Model	Description	Size	Pack
BGSW05X19"	GOLD single wall cake pad	05"x19"	100
BGSW09x13"	GOLD single wall cake pad	09"x13"	100
BGSW13x18"	GOLD single wall cake pad	13"x18"	100
BGSW18X26"	GOLD single wall cake pad	18"x26"	100

Model	Description	Size	Pack
BSSW05X19"	SILVER single wall cake pad	05"x19"	100
BSSW09x13"	SILVER single wall cake pad	09"x13"	100
BSSW13x18"	SILVER single wall cake pad	13"x18"	100
BSSW18X26"	SILVER single wall cake pad	18"x26"	100

Model	Description	Size	Pack
BFSW05X19"	FANTASY single wall cake pad	05"x19"	100
BFSW09x13"	FANTASY single wall cake pad	09"x13"	100
BFSW13x18"	FANTASY single wall cake pad	13"x18"	100
BFSW18X26"	FANTASY single wall cake pad	18"x26"	100

Model	Description	Size	Pack
BWSW05X19"	WHITE single wall cake pad	05"x19"	100
BWSW09x13"	WHITE single wall cake pad	09"x13"	100
BWSW13x18"	WHITE single wall cake pad	13"x18"	100
BWSW18X26"	WHITE single wall cake pad	18"x26"	100

Rectangular Cake Pad "BC" flute

Quarter-inch thickness

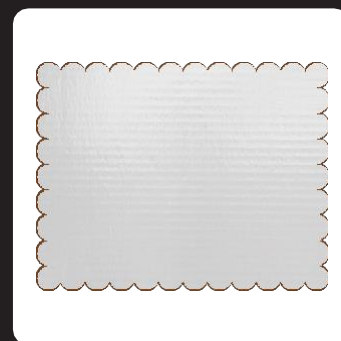
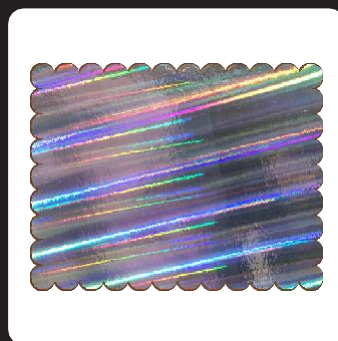
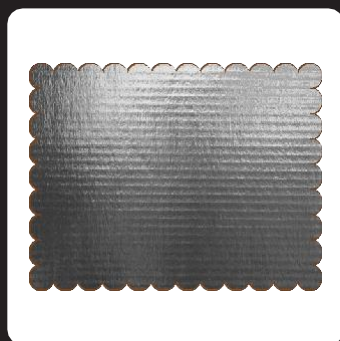
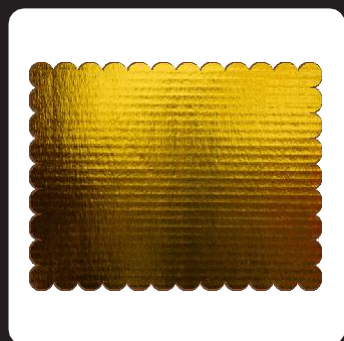
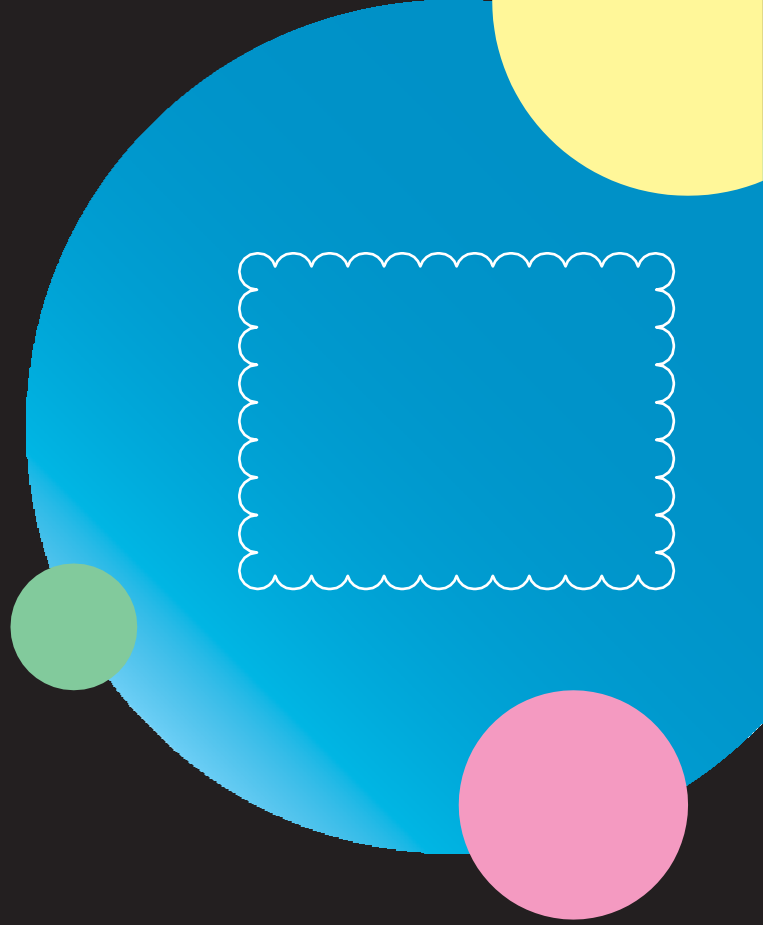
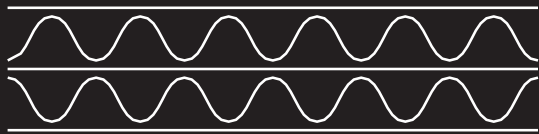

Our rectangular cake pads are perfect for displaying your rectangular cakes. Made from high-quality "BC" flute double-wall cardboard, these cake pads are extremely sturdy and durable. Available in 4 elegant colors - silver, gold, holographic, and white - the pad has a scalloped edge and a moisture-resistant metallic coating, ensuring that your cake stays in perfect condition.

Rectangle

Cake Pad "BC" flute

Model	Description	Size	Pack
BGDW05X19"	GOLD double wall cake pad	05"x19"	50
BGDW09X13"	GOLD double wall cake pad	09"x13"	50
BGDW13X18"	GOLD double wall cake pad	13"x18"	50
BGDW18X26"	GOLD double wall cake pad	18"x26"	50

Model	Description	Size	Pack
BSDW05X19"	SILVER double wall cake pad	05"x19"	50
BSDW09X13"	SILVER double wall cake pad	09"x13"	50
BSDW13X18"	SILVER double wall cake pad	13"x18"	50
BSDW18X26"	SILVER double wall cake pad	18"x26"	50

Model	Description	Size	Pack
BFDW05X19"	FANTASY double wall cake pad	05"x19"	50
BFDW09X13"	FANTASY double wall cake pad	09"x13"	50
BFDW13X18"	FANTASY double wall cake pad	13"x18"	50
BFDW18X26"	FANTASY double wall cake pad	18"x26"	50

Model	Description	Size	Pack
BWDW05X19"	WHITE double wall cake pad	05"x19"	50
BWDW09X13"	WHITE double wall cake pad	09"x13"	50
BWDW13X18"	WHITE double wall cake pad	13"x18"	50
BWDW18X26"	WHITE double wall cake pad	18"x26"	50

Round Embossed Cake Drum

Half-inch thickness

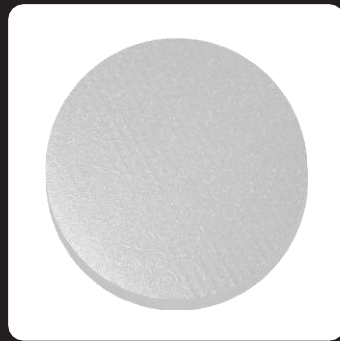
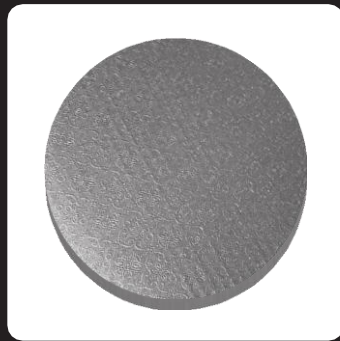
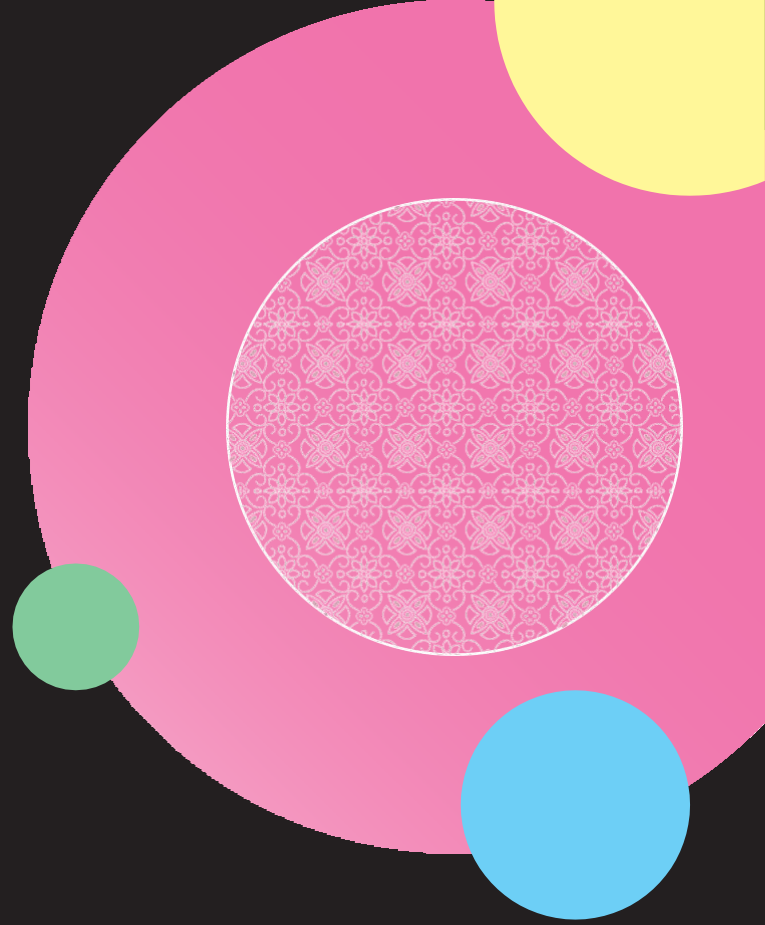

Introducing our round cake drum with an elegant embossed texture. Available in 4 colors - silver, gold, black, and white - our cake drum is extremely sturdy and durable. The drum has a moisture-resistant metallic coat, providing an elegant touch to your cake presentation.

Round Embossed Cake Drum

Model	Description	Size	Pack
GWECD08"	GOLD wrap embossed cake drum	08"	30
GWECD10"	GOLD wrap embossed cake drum	10"	30
GWECD12"	GOLD wrap embossed cake drum	12"	30
GWECD14"	GOLD wrap embossed cake drum	14"	30
GWECD16"	GOLD wrap embossed cake drum	16"	30
GWECD18"	GOLD wrap embossed cake drum	18"	30

Model	Description	Size	Pack
SWECD08"	SILVER wrap embossed cake drum	08"	30
SWECD10"	SILVER wrap embossed cake drum	10"	30
SWECD12"	SILVER wrap embossed cake drum	12"	30
SWECD14"	SILVER wrap embossed cake drum	14"	30
SWECD16"	SILVER wrap embossed cake drum	16"	30
SWECD18"	SILVER wrap embossed cake drum	18"	30

Model	Description	Size	Pack
WWECD08"	WHITE wrap embossed cake drum	08"	30
WWECD10"	WHITE wrap embossed cake drum	10"	30
WWECD12"	WHITE wrap embossed cake drum	12"	30
WWECD14"	WHITE wrap embossed cake drum	14"	30
WWECD16"	WHITE wrap embossed cake drum	16"	30
WWECD18"	WHITE wrap embossed cake drum	18"	30

Model	Description	Size	Pack
BWECD08"	BLACK wrap embossed cake drum	08"	30
BWECD10"	BLACK wrap embossed cake drum	10"	30
BWECD12"	BLACK wrap embossed cake drum	12"	30
BWECD14"	BLACK wrap embossed cake drum	14"	30
BWECD16"	BLACK wrap embossed cake drum	16"	30
BWECD18"	BLACK wrap embossed cake drum	18"	30

Rectangular Embossed Cake Pads

Half-inch thickness

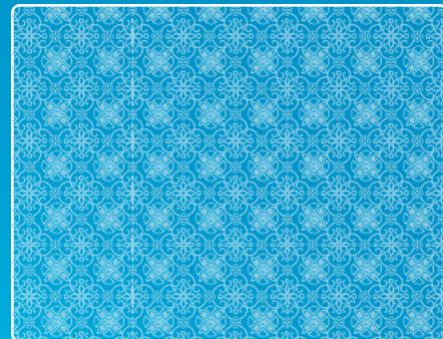

Our rectangular cake pads come with an elegant embossed texture, making them the perfect choice for displaying your rectangular cakes. Available in 4 colors - silver, gold, black, and white - the pad is extremely sturdy and durable. The pad has a moisture-resistant metallic coating, providing an elegant touch to your cake presentation.

Rectangular Embossed Cake Pads

Model	Description	Size	Pack
GWCEP08X08"	GOLD wrap embossed cake pad	08"x08"	30
GWCEP10X10"	GOLD wrap embossed cake pad	10"x10"	30
GWCEP12X12"	GOLD wrap embossed cake pad	12"x12"	30
GWCEP14X14"	GOLD wrap embossed cake pad	14"x14"	30
GWCEP16X16"	GOLD wrap embossed cake pad	16"x16"	30
GWCEP14X18"	GOLD wrap embossed cake pad	14"x18"	30
GWCEP17X25"	GOLD wrap embossed cake pad	17"x25"	30
GWCEP20X30"	GOLD wrap embossed cake pad	20"x30"	30
SWCEP08X08"	SILVER wrap embossed cake pad	08"x08"	30
SWCEP10X10"	SILVER wrap embossed cake pad	10"x10"	30
SWCEP12X12"	SILVER wrap embossed cake pad	12"x12"	30
SWCEP14X14"	SILVER wrap embossed cake pad	14"x14"	30
SWCEP16X16"	SILVER wrap embossed cake pad	16"x16"	30
SWCEP14X18"	SILVER wrap embossed cake pad	14"x18"	30
SWCEP17X25"	SILVER wrap embossed cake pad	17"x25"	30
SWCEP20X30"	SILVER wrap embossed cake pad	20"x30"	30
WWCEP08X08"	WHITE wrap embossed cake pad	08"x08"	30
WWCEP10X10"	WHITE wrap embossed cake pad	10"x10"	30
WWCEP12X12"	WHITE wrap embossed cake pad	12"x12"	30
WWCEP14X14"	WHITE wrap embossed cake pad	14"x14"	30
WWCEP16X16"	WHITE wrap embossed cake pad	16"x16"	30
WWCEP14X18"	WHITE wrap embossed cake pad	14"x18"	30
WWCEP17X25"	WHITE wrap embossed cake pad	17"x25"	30
WWCEP20X30"	WHITE wrap embossed cake pad	20"x30"	30
BWCEP08X08"	BLACK wrap embossed cake pad	08"x08"	30
BWCEP10X10"	BLACK wrap embossed cake pad	10"x10"	30
BWCEP12X12"	BLACK wrap embossed cake pad	12"x12"	30
BWCEP14X14"	BLACK wrap embossed cake pad	14"x14"	30
BWCEP16X16"	BLACK wrap embossed cake pad	16"x16"	30
BWCEP14X18"	BLACK wrap embossed cake pad	14"x18"	30
BWCEP17X25"	BLACK wrap embossed cake pad	17"x25"	30
BWCEP20X30"	BLACK wrap embossed cake pad	20"x30"	30

Round Ribbon Cake Board 2 "BC" heavy duty

Half-inch thickness

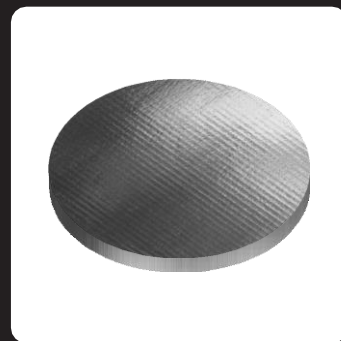
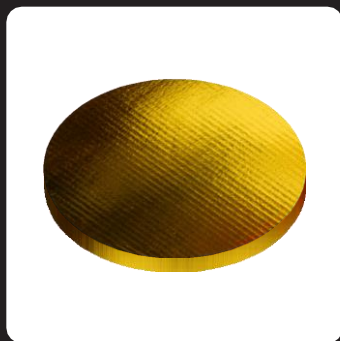
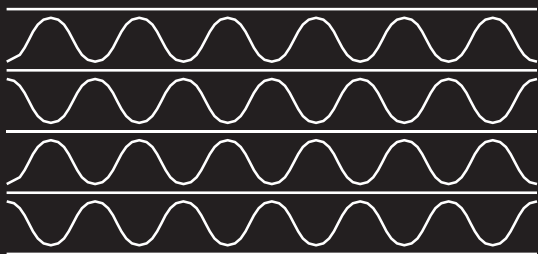

Our round cake boards are made from high-quality "BC" flute double-wall cardboard, making them the perfect choice for displaying heavy cakes. Available in 6 elegant colors - silver, gold, holographic, pink, black and white - the board is the most sturdy and durable among our cake boards and a moisture-resistant metallic coating and is finished with a beautiful ribbon around the edge, providing an elegant touch to your cake presentation.

Round

Ribbon Cake Board 2 "BC" heavy duty

Model	Description	Size	Pack
BGDR08"	GOLD cake board 2 "BC" heavy duty	08"	30
BGDR10"	GOLD cake board 2 "BC" heavy duty	10"	30
BGDR12"	GOLD cake board 2 "BC" heavy duty	12"	30
BGDR14"	GOLD cake board 2 "BC" heavy duty	14"	30
BGDR16"	GOLD cake board 2 "BC" heavy duty	16"	30
BGDR18"	GOLD cake board 2 "BC" heavy duty	18"	30

Model	Description	Size	Pack
BSDR08"	SILVER cake board 2 "BC" heavy duty	08"	30
BSDR10"	SILVER cake board 2 "BC" heavy duty	10"	30
BSDR12"	SILVER cake board 2 "BC" heavy duty	12"	30
BSDR14"	SILVER cake board 2 "BC" heavy duty	14"	30
BSDR16"	SILVER cake board 2 "BC" heavy duty	16"	30
BSDR18"	SILVER cake board 2 "BC" heavy duty	18"	30

Round Slim cake board "very sturdy"

2.5 millimeters

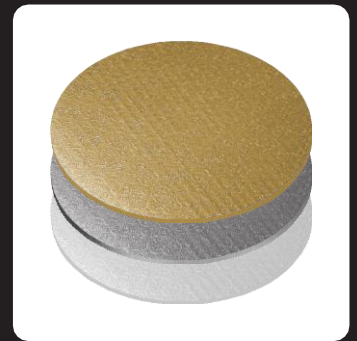
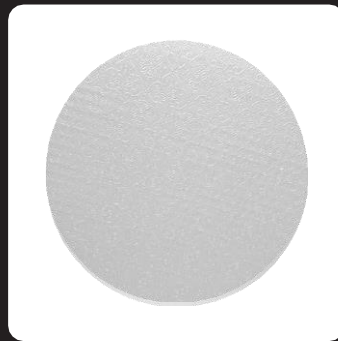
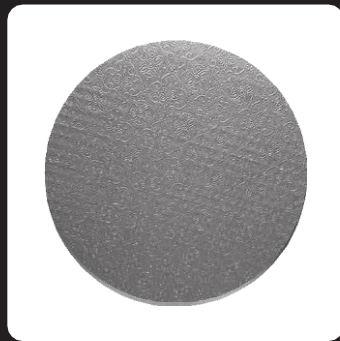
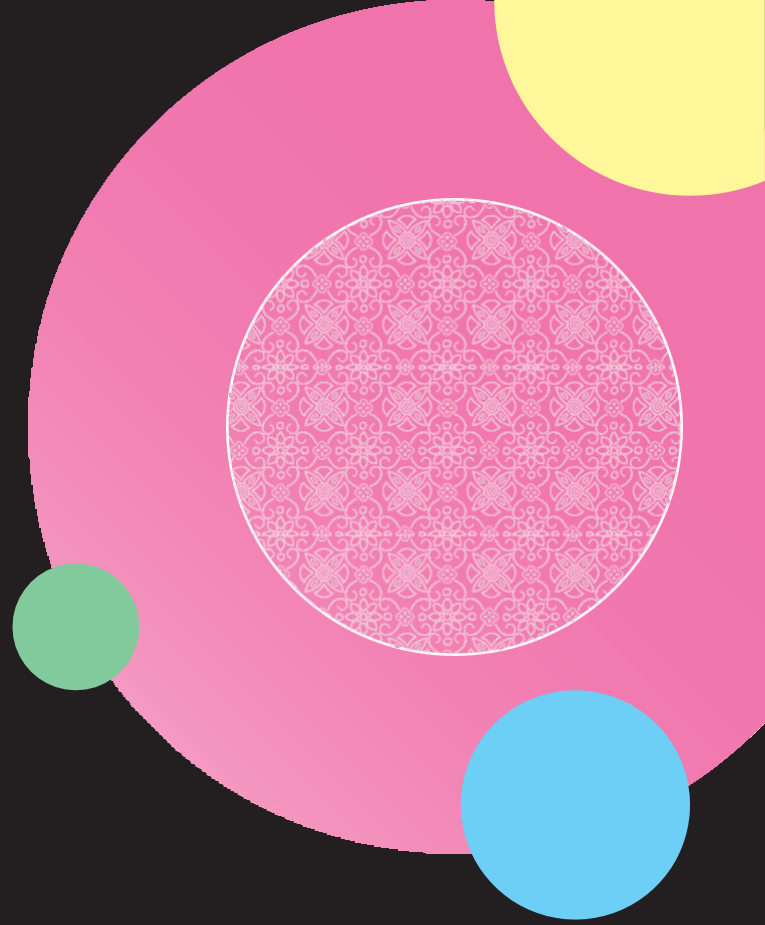

Our slim round cake board is made from a sturdy plastic material, providing a strong and durable base for your cakes. Available in 3 elegant colors - silver, gold, black and white - the board is moisture-resistant and has an embossed texture, adding an elegant touch to your cake presentation.

Round

Slim cake board "very sturdy"

Model	Description	Size	Pack
SGECB08"	GOLD embossed slim cake board 2.5 mm	08"	25
SGECB10"	GOLD embossed slim cake board 2.5 mm	10"	25
SGECB12"	GOLD embossed slim cake board 2.5 mm	12"	25
SGECB14"	GOLD embossed slim cake board 2.5 mm	14"	25

Model	Description	Size	Pack
SSECB08"	SILVER embossed slim cake board 2.5 mm	08"	25
SSECB10"	SILVER embossed slim cake board 2.5 mm	10"	25
SSECB12"	SILVER embossed slim cake board 2.5 mm	12"	25
SSECB14"	SILVER embossed slim cake board 2.5 mm	14"	25

Model	Description	Size	Pack
SWECB08"	WHITE embossed slim cake board 2.5 mm	08"	25
SWECB10"	WHITE embossed slim cake board 2.5 mm	10"	25
SWECB12"	WHITE embossed slim cake board 2.5 mm	12"	25
SWECB14"	WHITE embossed slim cake board 2.5 mm	14"	25

Model	Description	Size	Pack
SBECB08"	BLACK embossed slim cake board 2.5 mm	08"	25
SBECB10"	BLACK embossed slim cake board 2.5 mm	10"	25
SBECB12"	BLACK embossed slim cake board 2.5 mm	12"	25
SBECB14"	BLACK embossed slim cake board 2.5 mm	14"	25

Packstel Round Cake Board



The Packstel Round Cake Board: A trusted choice for professional bakers, providing unparalleled support and stability. With 0.1181" thickness it guarantees reliability for your cake displays. Made from sustainable materials, it offers an eco-friendly solution. The premium metallic gold finish adds sophistication, while the high-quality coated material ensures moisture resistance and grease proofing.

Packstel

Round cake board

Model	Description	Size	Pack
BGW08"	GOLD/WHITE Double coating cake board	08"	200
BGW10"	GOLD/WHITE Double coating cake board	10"	200
BGW12"	GOLD/WHITE Double coating cake board	12"	200

Model	Description	Size	Pack
BSW08"	SILVER/WHITE Double coating cake board	08"	200
BSW10"	SILVER/WHITE Double coating cake board	10"	200
BSW12"	SILVER/WHITE Double coating cake board	12"	200

Model	Description	Size	Pack
BWW08"	WHITE/WHITE Double coating cake board	08"	200
BWW10"	WHITE/WHITE Double coating cake board	10"	200
BWW12"	WHITE/WHITE Double coating cake board	12"	200

Mono portion boards "Frida"

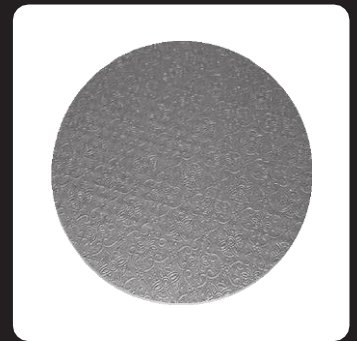
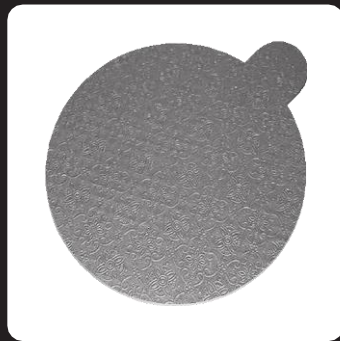
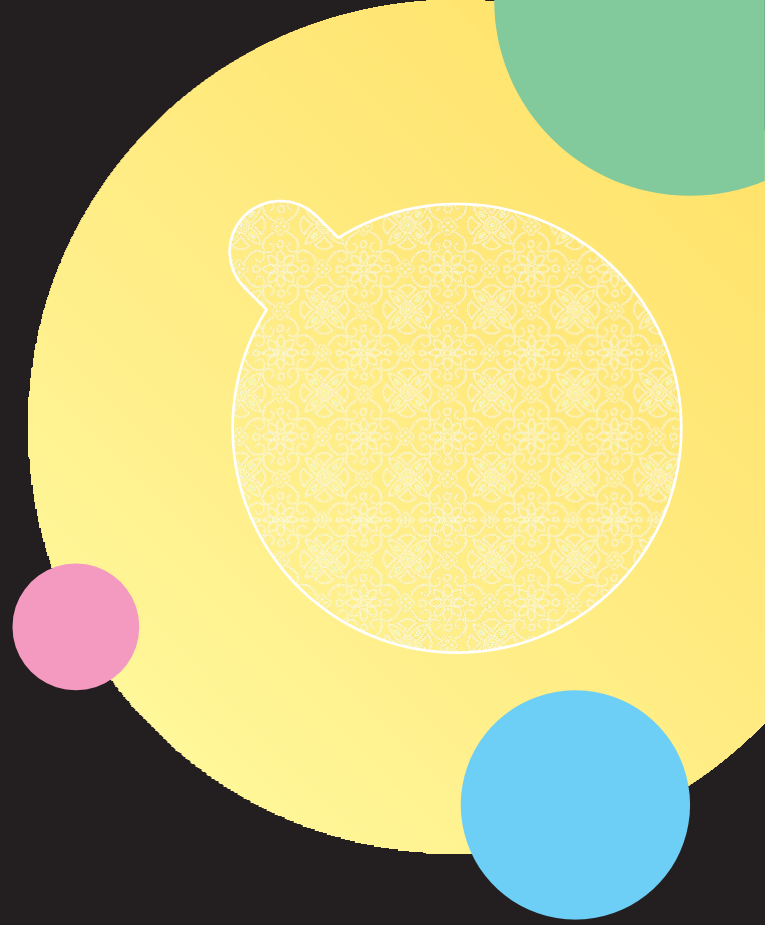

Introducing our mini round cake boards, perfect for serving small desserts. Available in 2 elegant colors - silver and gold - the boards come with and without a tab. The board has an embossed texture and a moisture-resistant metallic coating, ensuring that your desserts stay in perfect condition.

Mono portion Boards "Frida"

Model	Description	Size	Pack
DDFP03.15"	GOLD/White mini cake board with tab	3.15"	500
DDFP03.94"	GOLD/White mini cake board with tab	3.94"	500
DDFP04.72"	GOLD/White mini cake board with tab	4.72"	500

Model	Description	Size	Pack
DPFP03.15"	SILVER/White mini cake board with tab	3.15"	500
DPFP03.94"	SILVER/White mini cake board with tab	3.94"	500
DPFP04.72"	SILVER/White mini cake board with tab	4.72"	500

Model	Description	Size	Pack
DDF03.15"	GOLD/White mini cake board without tab	3.15"	500
DDF03.94"	GOLD/White mini cake board without tab	3.94"	500
DDF04.72"	GOLD/White mini cake board without tab	4.72"	500

Model	Description	Size	Pack
DPF03.15"	SILVER/White mini cake board without tab	3.15"	500
DPF03.94"	SILVER/White mini cake board without tab	3.94"	500
DPF04.72"	SILVER/White mini cake board without tab	4.72"	500

Donut Box

"CCNB"

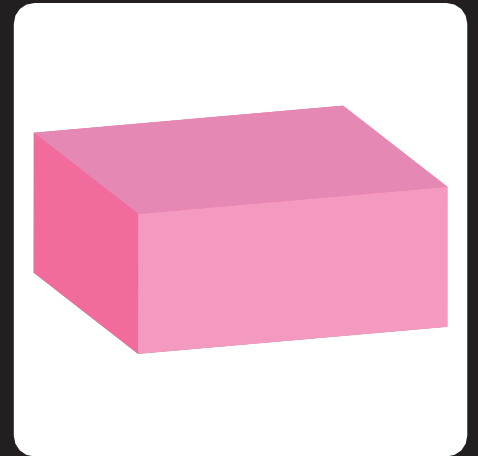
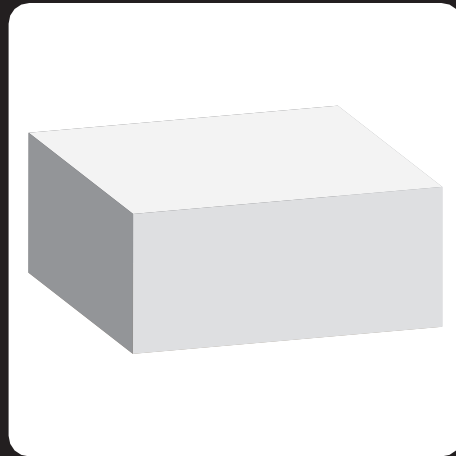
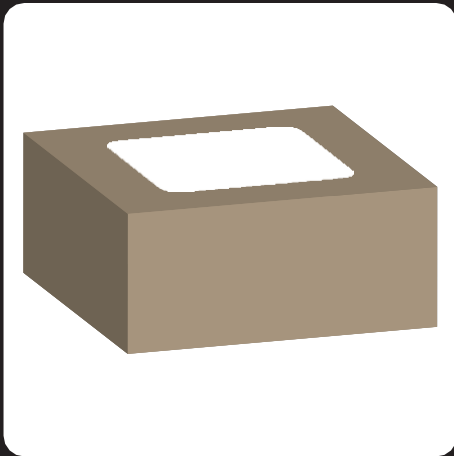
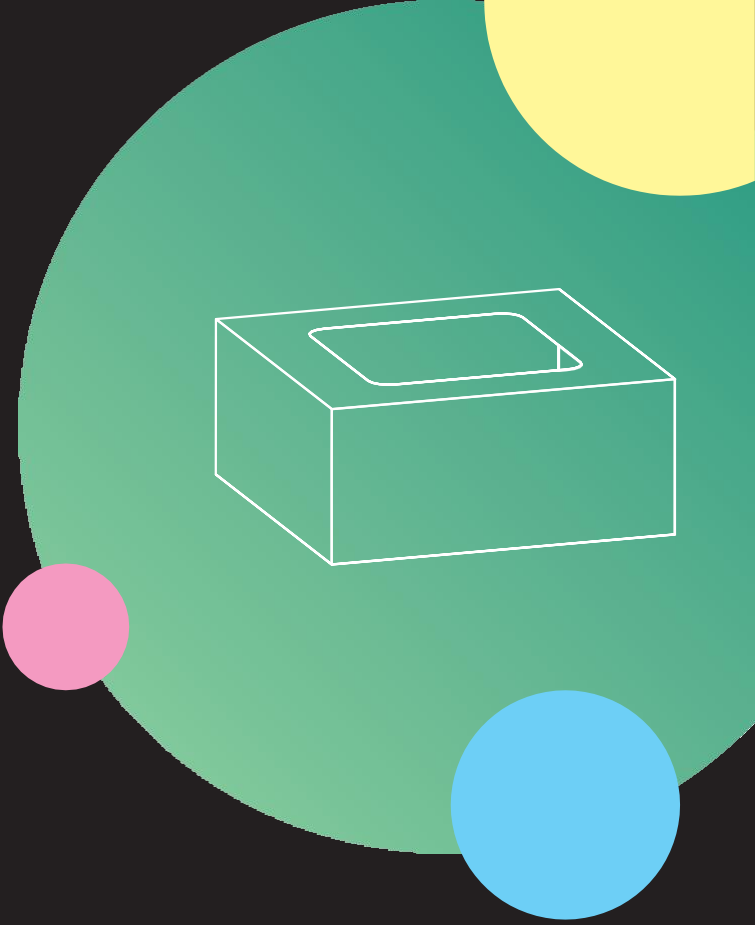

This donut carrier box comes in three sizes and three colors, pink, white, and kraft. It's made from CCNB, which provides good protection and durability for your donuts during transport. The box is easy to assemble and features a lid that securely closes to prevent the donuts from falling out. The size options allow you to transport anywhere from a small number of donuts to a large quantity, making it perfect for parties, events, and businesses.

Donut Box

"CCNB" flute

Model	Description	Size	Pack
94979	WHITE donut box without window	09"x09"x04"	200
94986	PINK donut box without window	09"x09"x04"	200
80866	KRAFT donut box with window	12.6"x09.45"x1.97"	200

Muffin box

"CCNB"

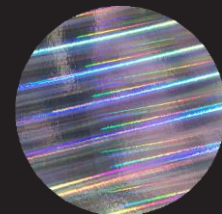
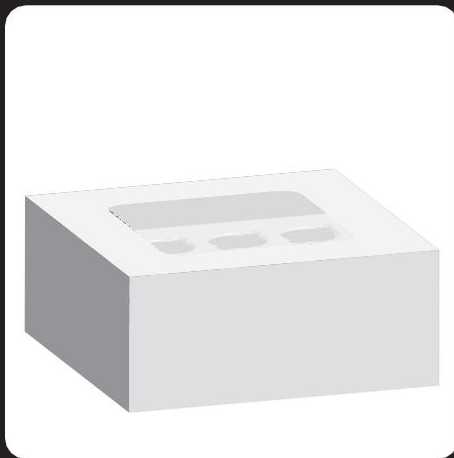
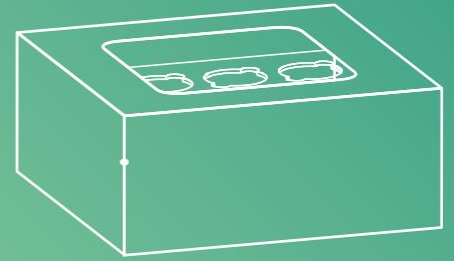

This muffin carrier box is available in five different sizes and three colors, silver, white, and holographic. The box is made from CCNB, which offers excellent durability and protection for your muffins while in transit. It features an easy-to-use lid that securely closes to keep your muffins fresh and in place. The range of sizes ensures that you can transport as many muffins as you need, whether it's for personal use or business purposes.

Muffin box

"CCNB"

Model	Description	Size	Pack
79242	SILVER muffin box for 01/P w/window	03.2"x3.2"x3.2"	200
81559	SILVER muffin box for 02/P w/window	06.4"x3.2"x2.8"	200
80750	SILVER muffin box for 04/P w/window	06.4"x6.4"x2.8"	200
80767	SILVER muffin box for 06/P w/window	09.6"x6.4"x2.8"	200
81535	SILVER muffin box for 12/P w/window	12.8"x9.6"x2.8"	200

Model	Description	Size	Pack
67560	WHITE muffin box for 01/P w/window	03.2"x3.2"x3.2"	200
67576	WHITE muffin box for 02/P w/window	06.4"x3.2"x2.8"	200
67249	WHITE muffin box for 04/P w/window	06.4"x6.4"x2.8"	200
67584	WHITE muffin box for 06/P w/window	09.6"x6.4"x2.8"	200
68383	WHITE muffin box for 12/P w/window	12.8"x9.6"x2.8"	200

Model	Description	Size	Pack
74795	FANTASY muffin box for 01/P w/window	03.2"x3.2"x3.2"	200
9469	FANTASY muffin box for 02/P w/window	06.4"x3.2"x2.8"	200
9470	FANTASY muffin box for 04/P w/window	06.4"x6.4"x2.8"	200
84574	FANTASY muffin box for 06/P w/window	09.6"x6.4"x2.8"	200
84581	FANTASY muffin box for 12/P w/window	12.8"x9.6"x2.8"	200

Model	Description	Size	Pack
GFM1	GOLDEN Frida's muffin box for 01/P w/window	03.2"x3.2"x3.2"	200
GFM2	GOLDEN Frida's muffin box for 02/P w/window	06.4"x3.2"x2.8"	200
GFM4	GOLDEN Frida's muffin box for 04/P w/window	06.4"x6.4"x2.8"	200
GFM6	GOLDEN Frida's muffin box for 06/P w/window	09.6"x6.4"x2.8"	200
GFM12	GOLDEN Frida's muffin box for 12/P w/window	12.8"x9.6"x2.8"	200

Model	Description	Size	Pack
SFM1	SILVER Frida's muffin box for 01/P w/window	03.2"x3.2"x3.2"	200
SFM2	SILVER Frida's muffin box for 02/P w/window	06.4"x3.2"x2.8"	200
SFM4	SILVER Frida's muffin box for 04/P w/window	06.4"x6.4"x2.8"	200
SFM6	SILVER Frida's muffin box for 06/P w/window	09.6"x6.4"x2.8"	200
SFM12	SILVER Frida's muffin box for 12/P w/window	12.8"x9.6"x2.8"	200

Hexagonal Cake Box "Chipboard"



This classic hexagonal cake carrier box is made from chipboard and features interlocking tabs that securely hold the lid in place. The white color of the box adds an elegant touch to your cake presentation, and the shape is perfect for adding a unique touch to any special occasion. The box is available in a single size, which accommodates a variety of cake sizes.

Hexagonal Cake Box "Chipboard"

Model	Description	Size	Pack
67874	WHITE hexagonal cake box	11.8"x11.8"x04.7"	50

Transporter

Cake Box

"C" flute



This cake carrier box is designed for easy transport and features a window on the front for an added visual appeal. The box is made from C flute, which provides excellent protection and durability during transport. It comes with an easy-to-carry handle that securely attaches to the top of the box with two tabs. The box is available in three sizes to accommodate different cake sizes and is perfect for businesses or individuals looking to transport cakes.

Transporter

Cake Box "C" flute

Model	Description	Size	Pack
74728	KRAFT transporter cake box	12"x12"x14"	12
74735	KRAFT transporter cake box	14.4"x14.4"x16"	12
74736	KRAFT transporter cake box	16"x16"x18"	12

Cake Box

with and without window

"E" flute

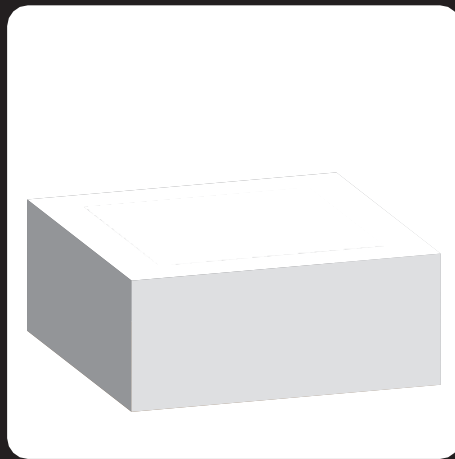
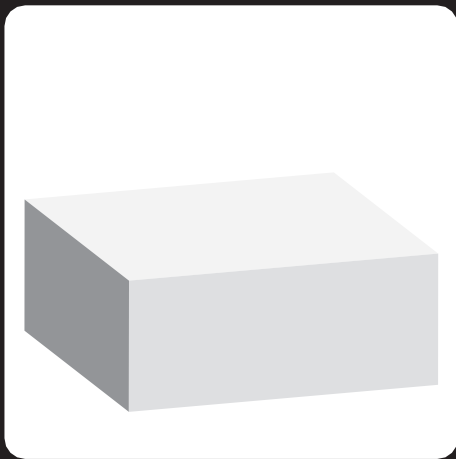
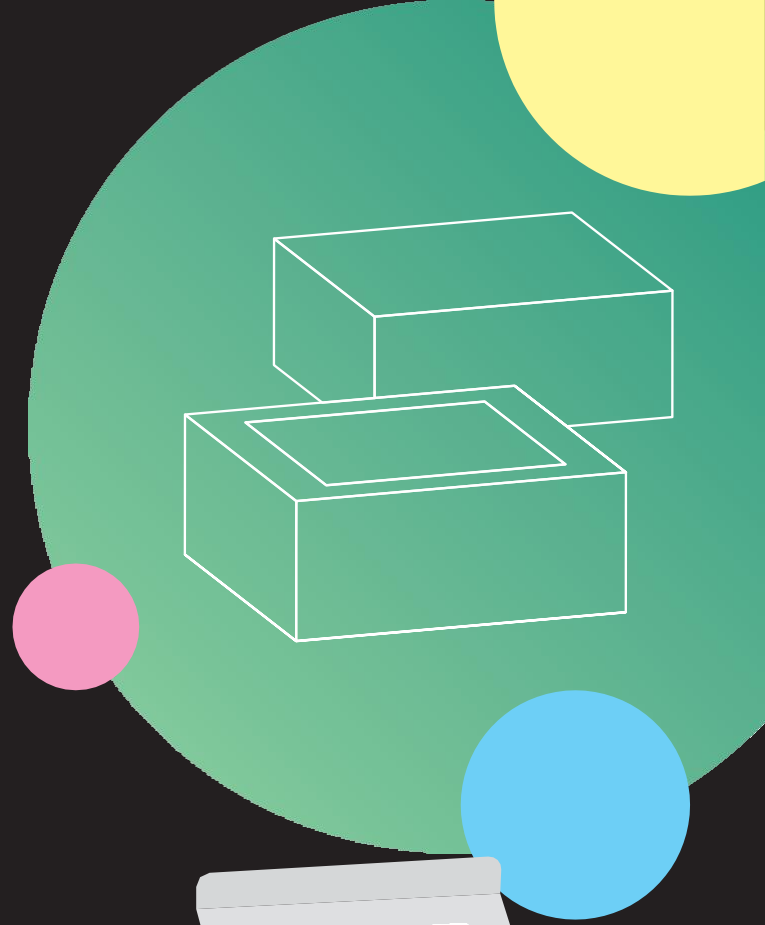

Our classic cake carrier box is crafted from durable E flute and includes a convenient lid and window, allowing you to showcase your delectable cake with ease. Available in nine sizes, these boxes accommodate cakes of various dimensions. The pristine white color adds a touch of professionalism, making it ideal for personal celebrations and business events alike.

For those seeking a timeless design, our windowless cake carrier box delivers. Made from sturdy E flute, this box ensures secure transportation with its reliable lid. With nine size options, it caters to cakes of diverse sizes, whether for personal enjoyment or professional endeavors.

Cake Box

without window "E" flute

Model	Description	Size	Pack
9442	WHITE box without window	06"X06"X5.12"	25
9443	WHITE box without window	08"X08"X5.12"	25
9444	WHITE box without window	10"X10"X5.12"	25
9445	WHITE box without window	12"X12"X5.12"	25
9446	WHITE box without window	14"X14"X5.12"	25
9447	WHITE box without window	16"X16"X5.12"	25
9448	WHITE box without window	09"X13"X5.12"	25
9449	WHITE box without window	13"X18"X5.12"	25
9450	WHITE box without window	18"X26"X5.12"	25

Cake Box

with window "E" flute

Model	Description	Size	Pack
95068	WHITE cake box with window	06"X06"X5.12"	25
93866	WHITE cake box with window	08"X08"X5.12"	25
92807	WHITE cake box with window	10"X10"X5.12"	25
92814	WHITE cake box with window	12"X12"X5.12"	25
92821	WHITE cake box with window	14"X14"X5.12"	35
92838	WHITE cake box with window	16"X16"X5.12"	25
95075	WHITE cake box with window	09"X13"X5.12"	25
95082	WHITE cake box with window	13"X18"X5.12"	25
95099	WHITE cake box with window	18"X26"X5.12"	25

Tall Cake Box with window "E" flute

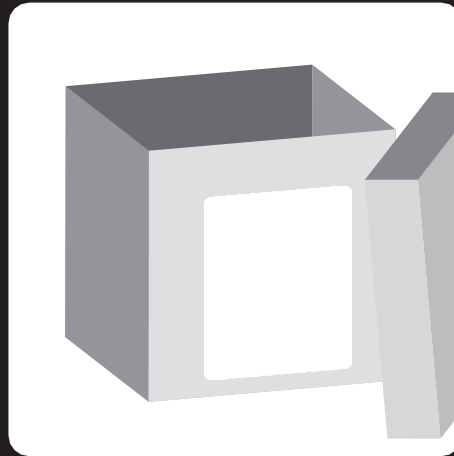
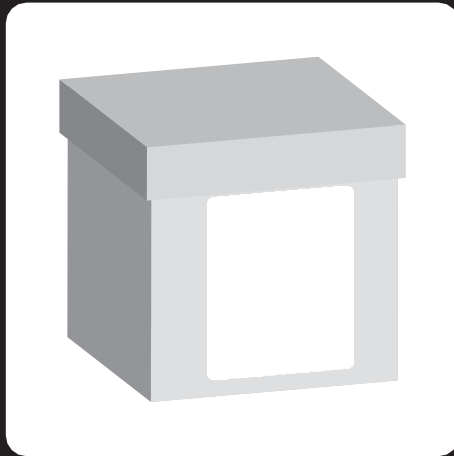
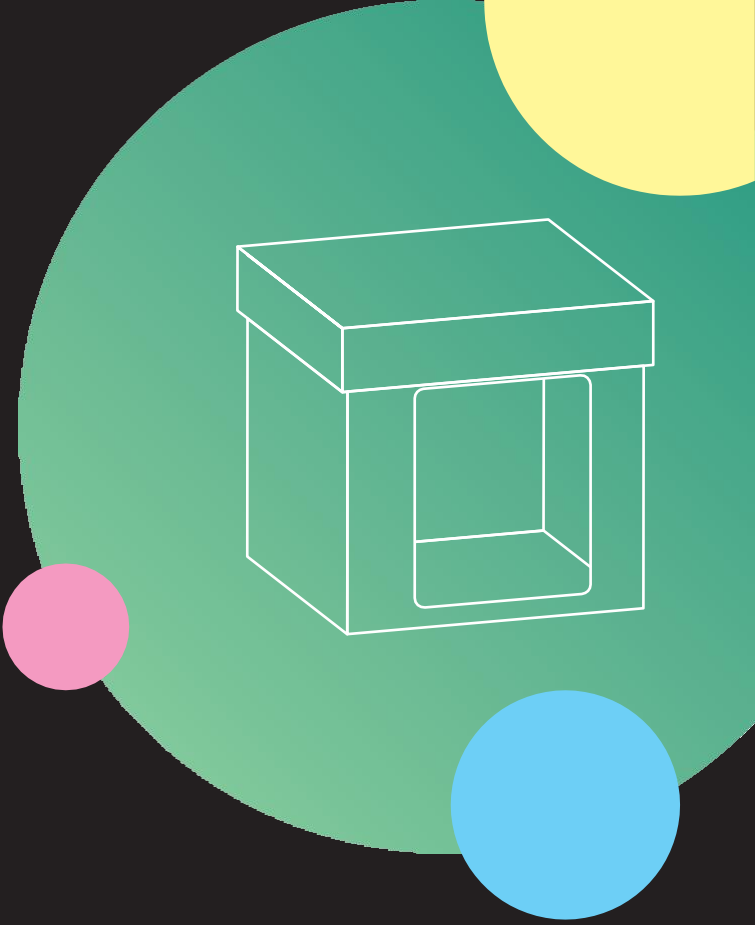

This cake carrier box is designed to accommodate taller cakes and is made from E flute for added durability. It features a front window that allows for easy viewing of your cake and comes with a separate top lid for added convenience. The box is available in three sizes, perfect for businesses or individuals looking to transport taller cakes.

Tall Cake Box

with window "E" flute

Model	Description	Size	Pack
96119	WHITE tall cake box with side window	7.87"x7.87x9.84"	25
92920	WHITE tall cake box with side window	10.24"x10.24"x10.24"	25
92937	WHITE tall cake box with side window	11.8"x11.8"x11.08"	25
96126	WHITE tall cake box with side window	14.17"x14.17x9.84"	25
96133	WHITE tall cake box with side window	15.75"x15.75"x9.84"	25

Surprise Cake Box "E" flute

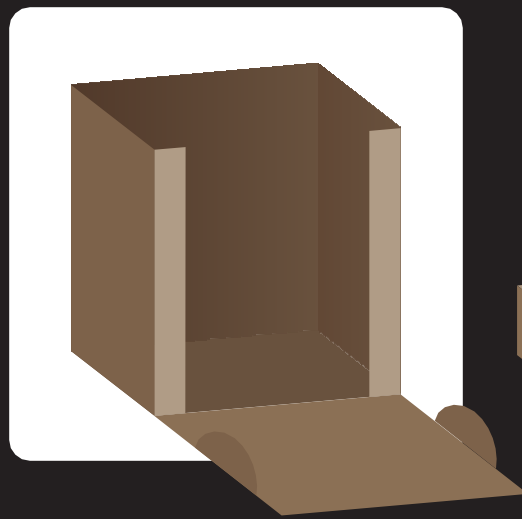
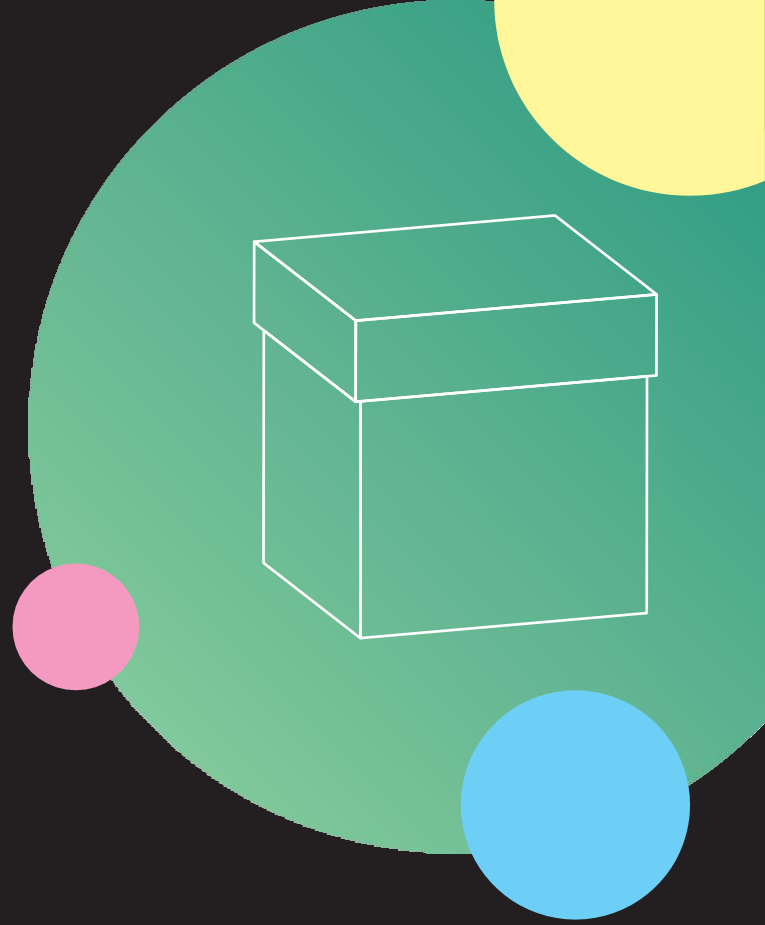

This high-resistance cake carrier box features an E flute construction and a separate top lid. The unique feature of this box is the way it opens - the front of the box swings open, creating a surprise reveal of your cake. The white color of the box adds an elegant touch, making it perfect for special occasions. It's available in a single size, perfect for transporting a medium-sized cake.

Surprise

Cake Box "E" flute

Model	Description	Size	Pack
84741	KRAFT Surprise cake box with cover	10.4"x10.4"x12"	50

Cardboard Bakeable Box

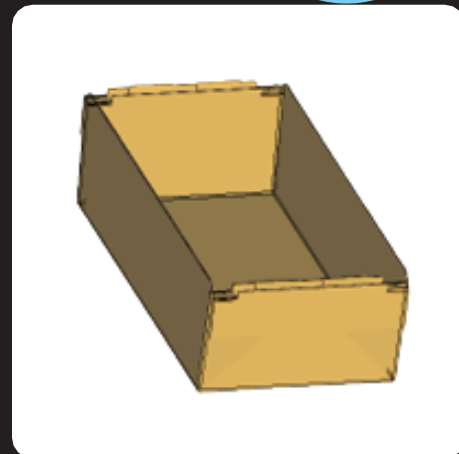
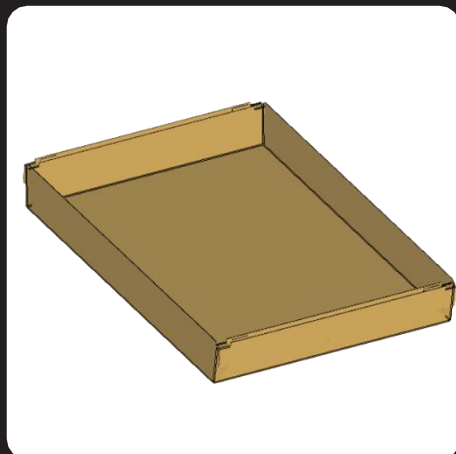
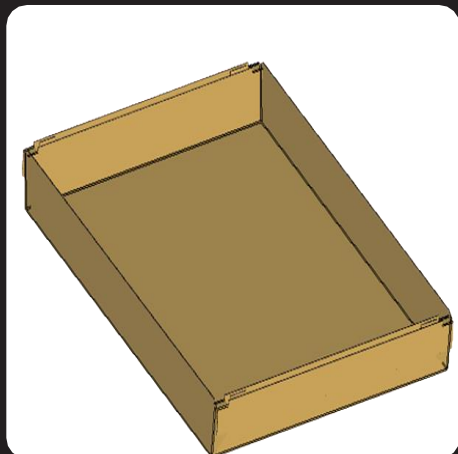
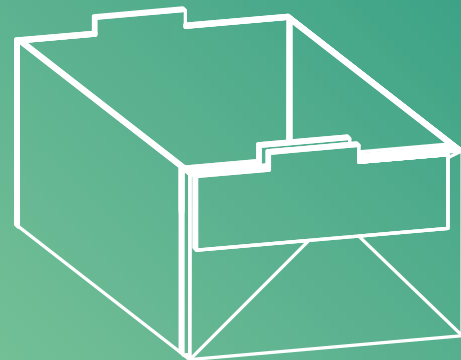

Introducing our eco-friendly bakeable cardboard box, designed to simplify your baking and serving experience. Made from sustainable materials, this sturdy box allows you to prepare and serve your treats directly from it, eliminating the need for additional dishes. Its compact size and secure design make it perfect for on-the-go indulgence, while maintaining the freshness and safety of your delectable creations.

Cardboard Bakeable Box

Model	Description	Size	Pack
KBKTP	BAKABLE box with transparent coating	3.74"x7.09"x2.56"	200
KBKTQP	BAKABLE box with transparent coating	09"x13"x2.56"	200
KBKTHP	BAKABLE box with transparent coating	13"x18"x2.56"	100

Model	Description	Size	Pack
KBKSP	BAKABLE box with silver coating	3.74"x7.09"x2.56"	200
KBKSQP	BAKABLE box with silver coating	09"x13"x2.56"	200
KBKSHP	BAKABLE box with silver coating	13"x18"x2.56"	100

Model	Description	Size	Pack
KBKBP	BAKABLE box with black coating	3.74"x7.09"x2.56"	200
KBKBQP	BAKABLE box with black coating	09"x13"x2.56"	200
KBKBHP	BAKABLE box with black coating	13"x18"x2.56"	100

Paper stick

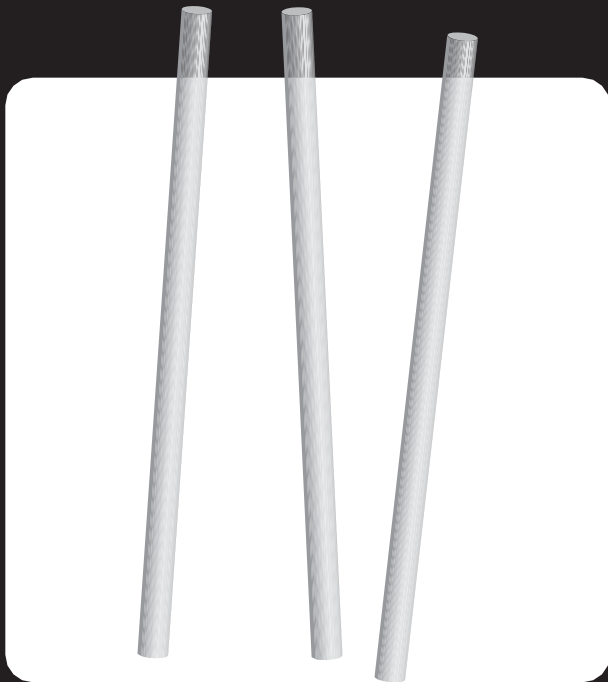

These paper sticks come in three sizes and are an eco-friendly alternative to traditional plastic sticks. They are perfect for serving donuts, cake pops, and other treats. The paper material is sturdy and durable, making it a great option for transporting treats during events or parties.

Paper stick

Model	Description	Size	Pack
64583	WHITE paper sticks	3.90"x0.19"	50
64590	WHITE paper sticks	5.90"x0.19"	50
94511	WHITE paper sticks	8.66"x0.19"	50

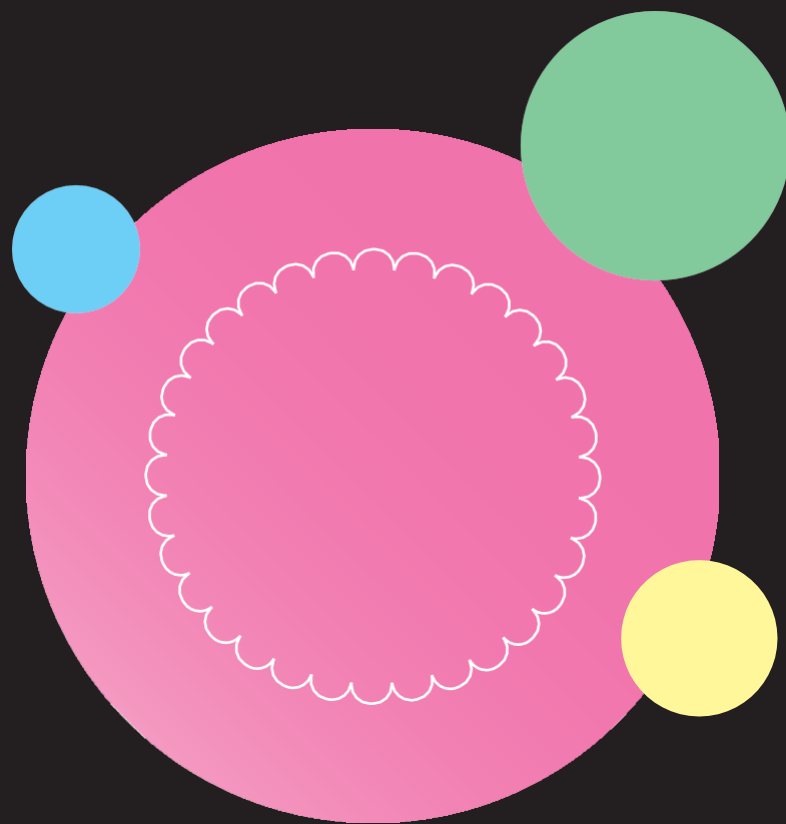

pastelobases.com